

## SOLUTIONS FOR INFILLED MASONRY BUILDINGS: SHAKING TABLE TESTS

**Leite, Joao<sup>1</sup>; Lourenco, Paulo B.<sup>2</sup>**

<sup>1</sup> MSc, PhD Student, University of Minho, ISISE, joaoleite@civil.uminho.pt

<sup>2</sup> PhD, Full Professor, University of Minho, ISISE, pbl@civil.uminho.pt

Infilled masonry can be seen as an old research issue, but recent seismic activities, such as the 2009 Aquila earthquake in Italy, showed seismic engineers and structural designers that current infill solutions may not work as expected. In this seismic action, the analysis of the damages in buildings constructed in the last 20 years, designed according to modern standards, may lead to the worrying conclusion that the design Limit States were not fulfilled. Taking this into account, a research program was conducted as a partnership between the University of Minho, Portugal, and the National Laboratory for Civil Engineering (L.N.E.C.), Portugal, which included a shaking table experimental program. The objective of this program was to study the seismic behaviour of the most common infill solution in Portugal, the unreinforced double leaf clay brick masonry, and two reinforced solutions referenced in the standard Eurocode 8: i) single leaf clay brick with bed joint reinforcement, connected to the bounding frame; ii) single leaf clay brick with steel net in the plaster, connected to the bounding frame. The present paper details the first two tested solutions, along with the discussion of the results, focusing on the obtained collapse modes of the infills and the measured accelerations for those modes.

*Keywords: infill, concrete frame, reinforcement, shaking table, collapse mode*

### INTRODUCTION

Seismic design has two main objectives, namely to: i) prevent local or global collapse of the structure in the event of the design seismic action, retaining structural integrity and residual load bearing capacity after the event - Ultimate Limit State requirement; ii) Withstand a more frequent seismic action without significant damage – Serviceability Limit State requirement. In other words, human lives have to be protected and damage has to be limited in order to keep the rehabilitation of the structure economically feasible. These are the objectives clearly stated in Eurocode 8 (EC8) (Eurocode-8, 2004).

Furthermore, this new standard imposes new rules for non-structural members, as in the case of masonry infills. It is stated in article 4.3.6.4 of part 1 of EC8 (Eurocode-8, 2004) that the brittle collapse of the infills has to be avoided and that light wire meshes or bed joint reinforcement have to be used. Besides this general information, no more details are given, so there is insufficient information for the structural engineer to correctly design the infills.

It may be stated that infills have been sufficiently studied in the past, but recent seismic activities, such as the 2009 Aquila earthquake in Italy, showed seismic engineers and structural designers that current infill solutions may not work as expected. In this seismic action, the analysis of the damages in buildings constructed in the last 20 years, designed according to modern standards, may lead to the worrying conclusion that the design Limit States were not fulfilled. The non fulfilment of the Serviceability Limit State can make the rehabilitation of a building economically unfeasible. As an example, in Parnitha, Greece (1999), 60% of the repair costs were due to damage in the infills. Even worst, the non fulfilment of the Ultimate Limit State, especially if the infill collapses out-of-plane, puts human lives at risk. The images of these disasters are widely available, reminding engineers of the consequences of bad practice or solutions.

New generations of seismic standards have been created and applied, but still the behaviour of masonry infill walls has not improved enough. With the objective of creating simple design rules for these infills, a shaking table test program, performed in LNEC as a partnership with the University of Minho, was developed.

### TESTING MODELS

The geometry of the tested models was based on a previous study where the average number of storeys, number of bays, and dimensions of the frames and infills was determined. Also, the physical limitations of the shaking table in use had to be taken into account so that the scaled model would fit on the platform, see Figure 1, and would not be excessively heavy.

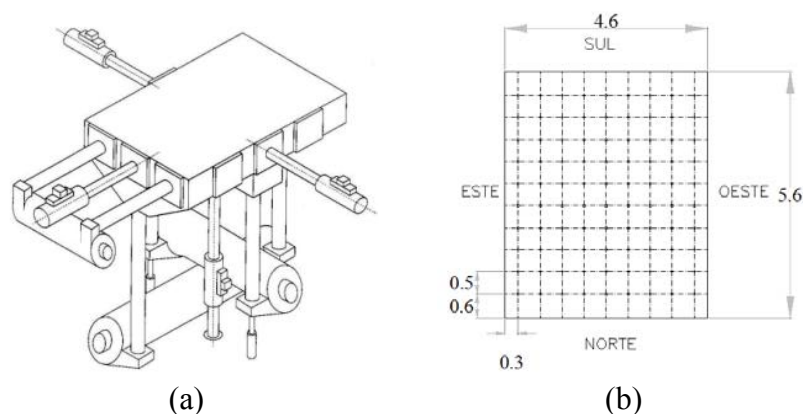

**Figure 1: Shaking table of the National Laboratory for Civil Engineering: (a) general view; (b) dimensions of the platform in meters**

In order to study the different infill solutions, and to correctly represent typical buildings, the structure of the first building was designed following the previous Portuguese standards, R.S.A (R.S.A., 1983) and R.E.B.A.P.(R.E.B.A.P., 1983), while the other two were designed following EC2 (Eurocode-2, 2002) and EC8 (Eurocode-8, 2004). The infill solutions of model one are unreinforced cavity walls and the most common ones, while in the other model single leaf infills are reinforced following the articles of EC8 (Eurocode-8, 2004). For design purposes, the structure is located in the city centre of Lisbon, Portugal.

The reduction of the dimensions, and all other parameters needed to design the models, was done using Cauchy-Froude's similitude law, see Cauchy is adequate when the restoring forces are derived from the stress-strain relationships and Froude is adequate when the gravity forces are important. For highly non-linear dynamic responses, both laws need to be taken into account (Carvalho, 1998), which is the case of the presented experimental tests.

Table 1, for a scale of 1:1,5 ( $\lambda = 1,5$ ), with the final geometry resumed in Figure 2. Cauchy is adequate when the restoring forces are derived from the stress-strain relationships and Froude is adequate when the gravity forces are important. For highly non-linear dynamic responses, both laws need to be taken into account (Carvalho, 1998), which is the case of the presented experimental tests.

**Table 1: Cauchy-Froude's similitude law**

Parameter	Scale Factor	Parameter	Scale Factor
Length (L)	$L_p/L_m = \lambda$	Mass (m)	1
Young's Module (E)	$E_p/E_m = 1$	Weight (w)	$\lambda^2$
Specific Mass ( $\rho$ )	$\rho_p/\rho_m = \lambda^{-1}$	Force (F)	$\lambda^2$
Area (A)	$\lambda^2$	Moment (M)	$\lambda^3$
Volume (V)	$\lambda^3$	Stress ( $\tau$ )	1
Displacements (d)	$\lambda^2$	Strain ( $\epsilon$ )	1
Velocity (v)	$\lambda$	Time (t)	$\lambda^{1/2}$
Acceleration (a)	$\lambda^{1/2}$	Frequency (f)	$\lambda^{-1/2}$

The use of Froude's law implies additional masses, because of the relation of the specific mass of the prototype and the model. These masses have to be applied to all materials, and in the tested models, only two different solutions for all materials were needed: one for the concrete structure and all the dead and live loads at the floors; another one for the infill masonry walls. These are detailed next.

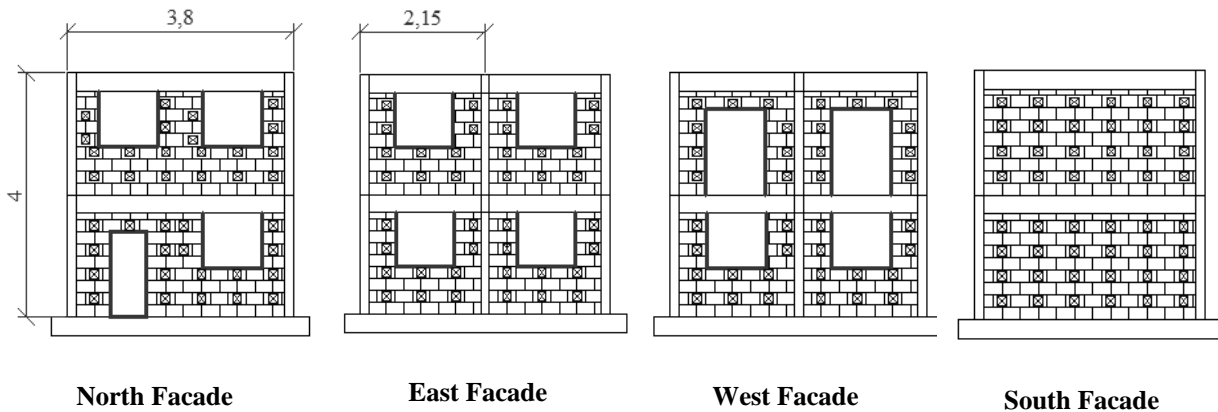

**Figure 2: Facades and dimensions, in meters, of the tested models.**

It was stated above that two different infill solutions were used for models one and two. Figure 3 shows the details of the solution of model one and its construction. It is a double leaf clay brick cavity wall, unreinforced, and with pre-batched mortar in the bed joints and outer rendering, and it is the most common infill solution used in Portugal in the last two decades.

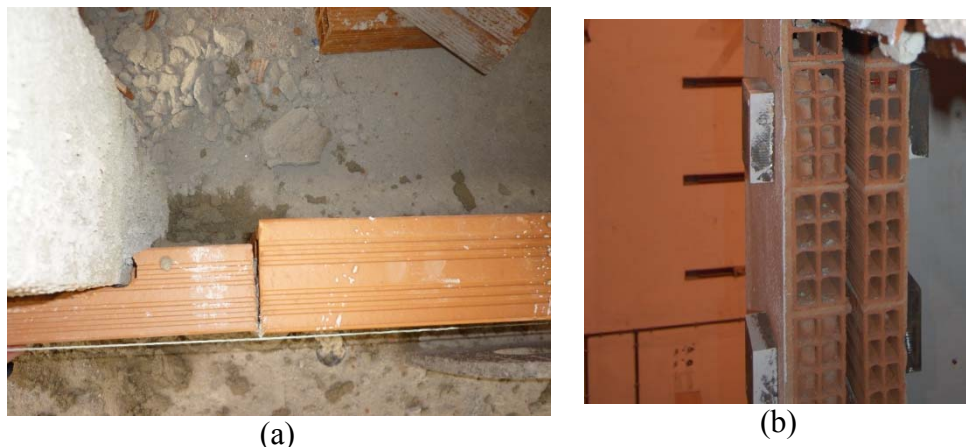
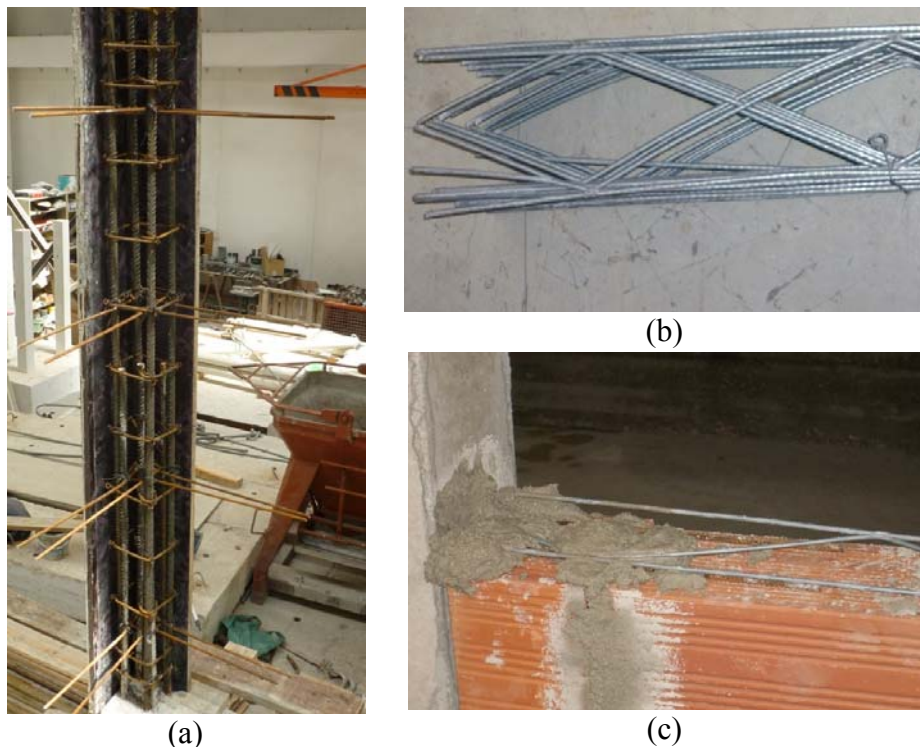

**Figure 3: Infill solution of model one, a double leaf clay brick cavity wall with pre-batched mortar: (a) outer leaf; (b) final work with mortar rendering outside and plaster inside**

The infill solution of model two is single leaf, also with clay bricks and pre-batched mortar, but with bed joint reinforcement connected to the columns of the reinforced concrete frame. The connectors (standard ribbed bars) used were attached to the longitudinal reinforcement steel bars of the columns during construction phase, see Figure 4 (a). The bed joint reinforcement chosen was BEKAERT – MURFOR RND.4/100, see Figure 4 (b), every two courses. The amount of reinforcement was defined following articles 8.2.2, 8.2.3 and 8.2.7 of EC8 (Eurocode-8, 2004). The extra mass needed for the concrete structure, due to similarity law, was obtained by attaching the calibration masses of the shaking table. Each one has approximately 1200 kg and 82x82x26 cm<sup>3</sup>, and six were attached to each floor. Figure 3 (b) shows the masses used for the infill masonry walls. Each one has approximately 7,2 kg and 15x15x4 cm<sup>3</sup>. With these dimensions, one steel plate can be attached to a single block and will not connect blocks mechanically. A total number of 334 steel plates were used in each

model, half in the inside part of the model and the other half externally. In total, each model weighted about 41 tons.

Two different types of behaviour needed to be analysed in the tests: i) the global behaviour of the concrete structure; ii) the local behaviour of the infills. The first was captured using with Hamamatsu cameras at the corners of the building and accelerometers in two corners of each slab, see Figure 4 (a). The local behaviour of the infill walls was measured using accelerometers, see Figure 5 (b), and in model one, because of the double leaf infill solution constructed, accelerometers had to be placed in the inside and outside, in opposite positions. A total number of 48 accelerometers and 8 Hamamatsu cameras, measuring two in-plane directions, were used.



**Figure 4: Infill solution of model two, a single leaf clay brick wall with pre-batched mortar and bed joint reinforcement: (a) connectors of the bed joint reinforcement to the longitudinal reinforcement steel bars of the columns; (b) Bekaert Murfor RND.4/100; (c) bed joint reinforcement over the connectors in the bed joint layer**

Hamamatsu cameras, model Photonics C5949, are a high resolution position measuring system based on a non-discrete camera and an infra-red led. The camera measures the planar movement of the led. The accelerometer measures unidirectional accelerations within a certain range. The PCB Piezotronics models attached to the structure had a measurement range of  $\pm 5g$ . All the measuring instruments were conditioned with cards from PCB Piezotronics (481A02) and National Instruments (series 1300 SCXI modules) inserted into a PXI-1052 from National Instruments.

EC8 (Eurocode-8, 2004) defines in article 2.1(1) that the design seismic action should have 475 years of return period although, depending on the importance class of the structure, table 4.3 of the standard, the maximum surface acceleration should be changed, therefore changing the return period of the seismic action. Part 3 of EC8 (Eurocode-8, 2005) states in article 2.1 that there are three different Limit States, in order to assess and classify the seismic performance of a structure. Each one (NC – near collapse, SD – significant damage, DL – damage limitation) has to be assessed using a seismic action with different years of return period (225, 475 and 2475 years, respectively).



**Figure 5: Instrumentation of the model using accelerometers: (a) in the concrete structure (corner of the slab measuring transversal directions); (b) infill walls (South wall, storey 1)**

The stages of the shaking table tests, see Table 2, were defined regarding these Limit States. For each stage, an artificial accelerogram, based on the response spectrum, was generated and used as the input signal. The last stage, number four, was defined as the maximum capacity of the table for the mass of the studied structure. At the beginning, between each stage and at the end, a modal characterization was carried out using a white noise low signal as input. The objective is to determine the dynamic parameters of the structure and their evolution.

**Table 2: Stages of the experimental tests for each model**

Stage	Years of return period
1	225
2	475
3	2475
4	1,5 x stage 3

The artificial accelerograms were generated in LNEC-SPA – *Signal Processing and Analysis Tools for Civil Engineers*, software developed in LNEC, and two different accelerograms had to be generated for each stage, one for the longitudinal (N-S) and other for the transversal (E-W) directions. Each stage was tested with masses attached to the table before the actual test in order to understand the behaviour of the tri-axial platform and make the necessary calibration. The vertical component was not used.

## RESULTS

Both models were subjected to the four stages above defined and model 1 collapsed during the last one, due to shear failure of the three columns of the West facade at mid-height and in the beam/column connection. Before that, all the infill walls of the lower storey had already been expelled out-of-plane. As for model 2, the concrete structure and the infills were heavily damaged, beyond repair, but there were no out-of-plane expulsions.

The values displayed in Figure 6 were obtained from the accelerometers placed inside the tri-axial platform and are the highest values measured in each stage of the tests. These peaks are due to the attempt of the actuators of the shaking table to follow the input at high frequencies. The size and mass of the structure are near the limit values of the equipment, meaning the tri-axial shaking table can slightly underperform and not completely follow the input. This fact is clearer in the longitudinal (N-S) direction which has only one actuator, on the South side, instead of one on each side, as in the transversal (E-W) direction. Therefore, sensitivity is lost when upper levels of demand are reached, as in stage three, so the actuator compensates by excess. The same happens in stage four, so similar values of acceleration were recorded. As for the acceleration values reached, both models were subjected to a similar input, even though the artificial accelerogram generated was based on different spectra. Comparing the recorded values with the design ones (converting them using the Cauchy-Froude's similarity law, see Table 1), therefore in stage two, the transversal values are similar (about 2% lower) and the longitudinal ones are higher (about 30%).

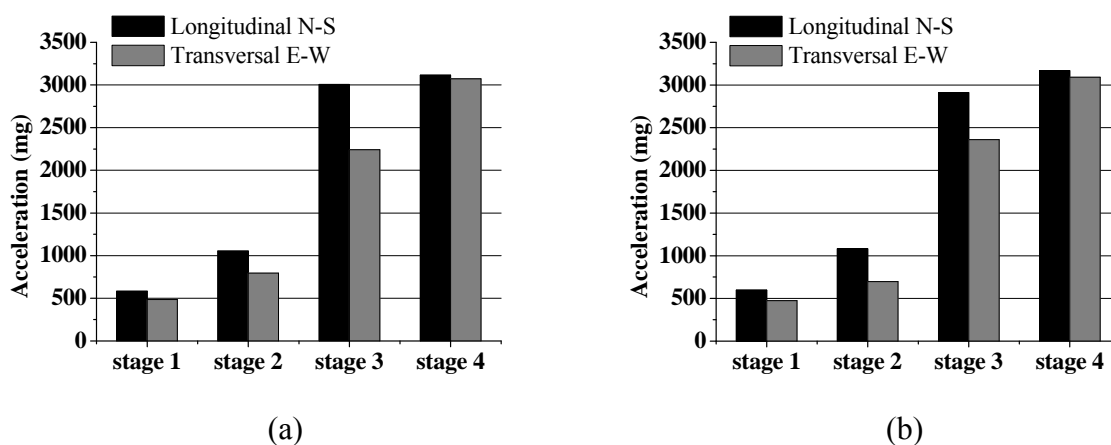

**Figure 6: Peak Ground Acceleration in each stage: (a) Model 1; (b) Model 2**

The infill walls' acceleration was measured using accelerometers, see Figure 5 (b), and in model 1, due to the double leaf solution used, they were placed on both sides of the wall. The geometrical position of the accelerometers was the same in both models, so the values could be compared. Figure 7 presents the highest value, measured by the group of accelerometers of each infill wall, during the last stage for both models and on both leaves in model 1 (the second storey of the North facade was not measured in model 2). Except for the East walls, the inner leaf of model 1 presents the highest values, while the outer leaf of the same model presents values slightly higher (16.5% at the most on S-1) than the infills of model 2. Comparing the inner and outer leaves of model 1, except for the East walls, the highest difference is 20% (N-2). It is interesting to notice that the infills in the lower storey register higher accelerations,

which is due to the greater amount of damage sustained, leading to a substantial loss of stiffness.

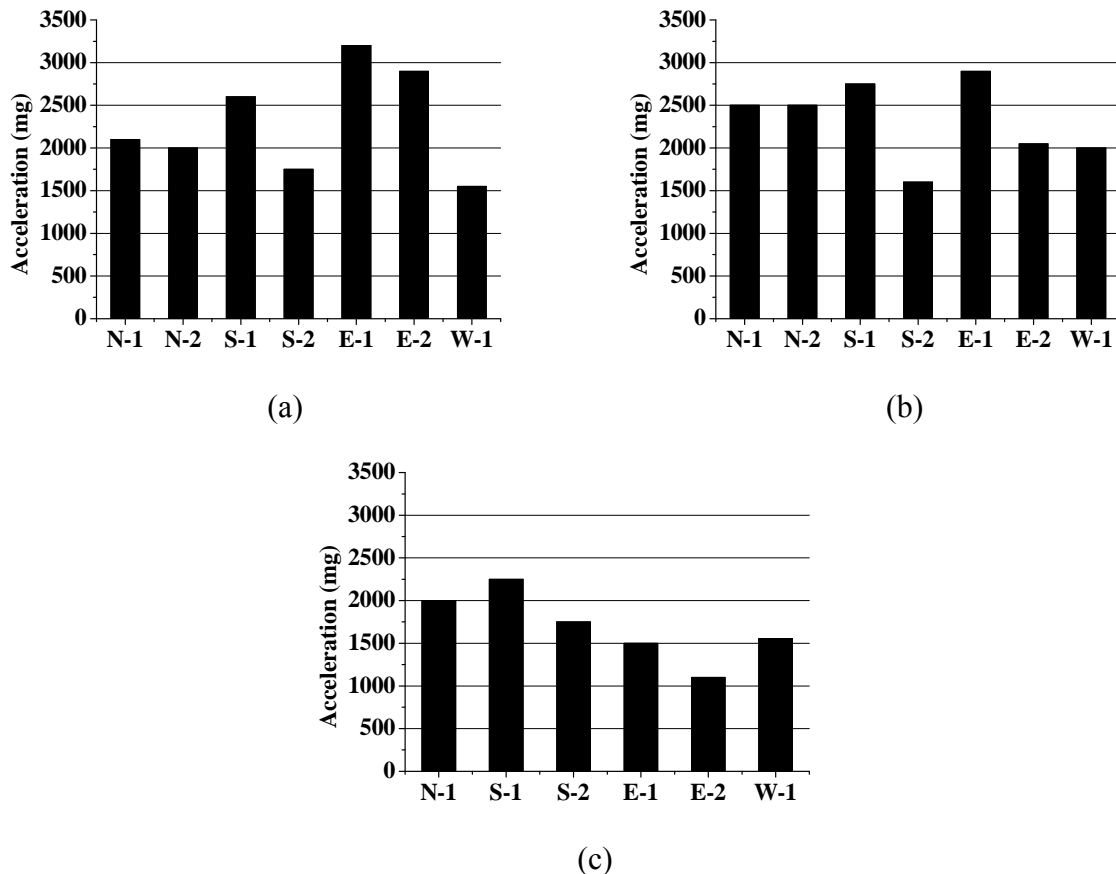

**Figure 7: Peak Acceleration measured in the infill walls in stage 4: (a) Model 1 – exterior leaf; (b) Model 1 – interior leaf; (c) Model 2**

As it was stated above, all the infill walls of the ground storey of model 1 were expelled out-of-plane. The outer leaf of the South wall was the first to collapse, completely detaching itself from the upper beam of the concrete frame and rotating around the base as a rigid body, see Figure 8 (a), shortly followed by the inner leaf which opened a crack parallel to the bed mortar joints, at mid-height and along the complete length, and then both upper and lower parts rotated out-of-plane around the upper and lower beams of the concrete frame, respectively, see Figure 8 (b). In the North wall, due the existence of openings, the collapse was in phases, but also with a rigid body rotation around the base for the central part of the wall, see Figure 8 (c) and Figure 8 (d). The threshold was expelled first and has a whole, see Figure 8 (a). The East and West walls had the exact same behaviour: first the central and lateral thresholds were expelled, as whole also, Figure 8 (e), followed by the lower lintel, which rotated around the base as rigid body, see Figure 8 (f).

None of the infills of model 2 were expelled out-of-plane during the last stage, even though they were subjected to similar accelerations, see Figure 7, as a result of the use of bed joint reinforcement connected to the reinforced concrete frame. The South wall presented cracks, mainly at the connection with the concrete frame, see Figure 9 (a), while the other three sides



were heavily damaged and beyond repair. The central portion of the infill in the North wall was completely disconnected from the concrete frame at the top, see Figure 9 (b), just as the thresholds in the East and West walls, see Figure 9 (c). In both cases the bed joint reinforcement was the only connection to the concrete frame, preventing the expulsion. All the rendering around the concrete frame in the lower storey fell.

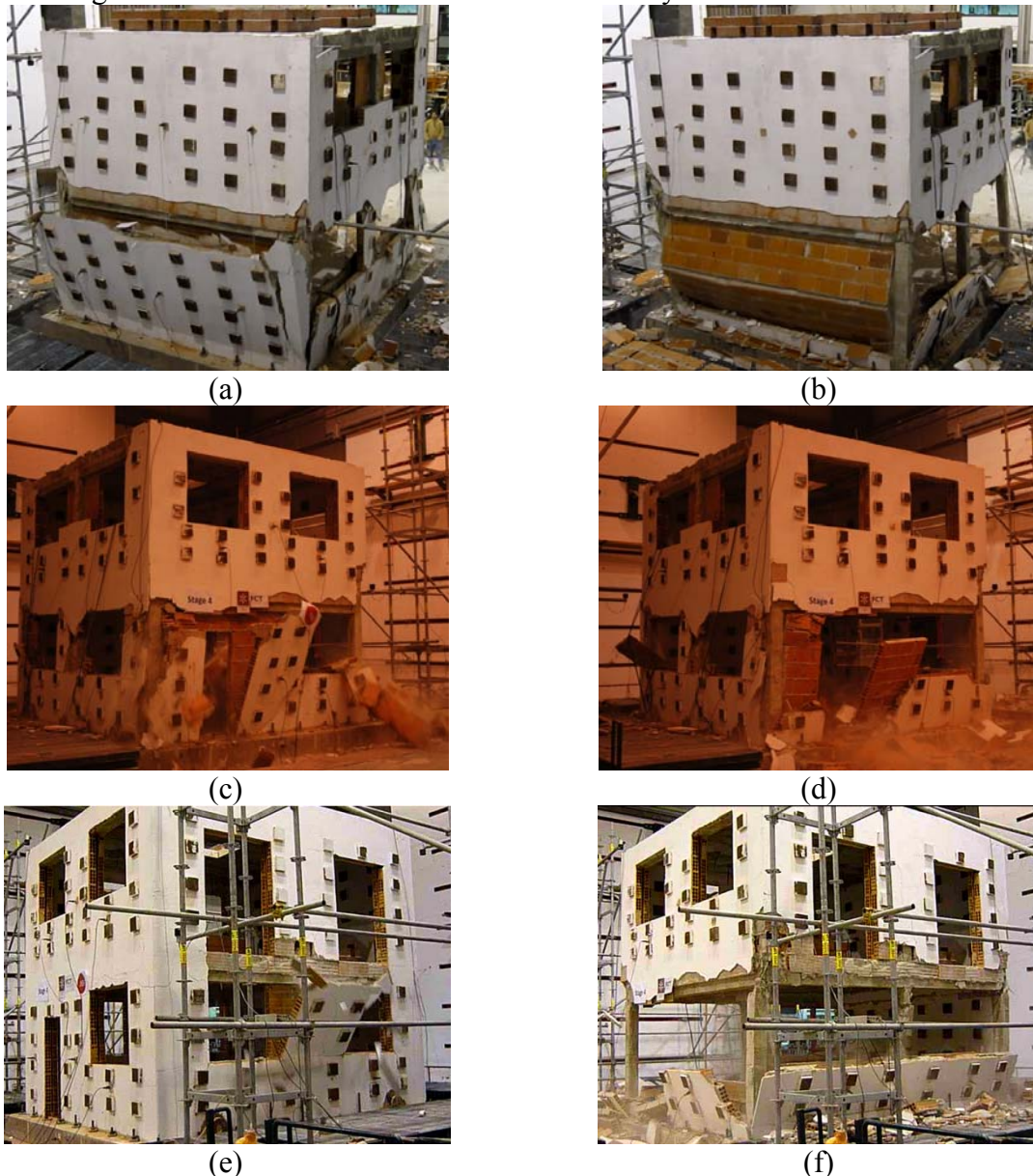

**Figure 8: Collapse (out-of-plane expulsion) of the infill walls in model 1 during the last stage: (a) outer leaf of the South wall; (b) inner leaf of the South wall; (c) and (d) North wall; (e) threshold of the West wall; (f) lintel of the West wall**

In this second model, the concrete structure was visibly damaged, with shear cracks at mid height of the columns and with the detachment of the cover concrete at the beam/column connection, both in the first floor. It is reasonable to claim that this model, despite its higher capacity to withstand the fourth stage of the test, was developing an undesirable soft storey failure mode due to the presence of the masonry infills and their damage at the lower storey.

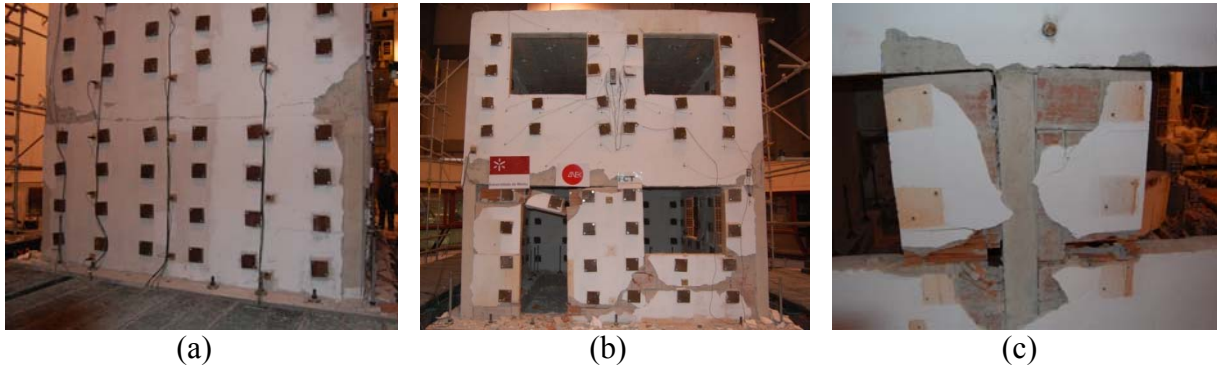

**Figure 9: Infill walls after stage 4: (a) South wall; (b) North wall; (c) detail of the threshold in the East wall**

## CONCLUSIONS

The present work is the first analysis of the results of two shaking table tests on masonry infilled reinforced concrete frames. A more careful study of these results needs to be done, along with numerical simulations, so that solid conclusions can be stated. The structure designed with the previous Portuguese standards and a double leaf cavity wall, model one, had a poor behaviour when compared with model two, designed according to Eurocodes with a single leaf larger wall. The first structure fully collapsed in the fourth and last stage of the test while the second structure was heavily damaged, beyond repair, but withstood all the stages, even though the developed failure mode was undesirable. All of the walls of the first storey of model one were expelled out-of-plane before the structure collapsed, while none of the walls of model two collapsed (even if significantly damaged). The better behaviour of the infills in model two was due to the presence of bed joint reinforcement connected to the infill frame.

## REFERENCES

- Carvalho E.C. Seismic testing of structures, 11th European Conference on Earthquake Engineering, Balkema, Rotterdam, 1998.
- Eurocode-2. Eurocode 2: Design of concrete structures - Part 1: General rules and rules for buildings, (EN-1992-1-1) European Committee of Standardization, Brussels, Belgium, 2002.
- Eurocode-8. Design of structures for earthquake resistance - Part 1: General rules, seismic actions and rules for buildings (EN 1998-1), European Committee of Standardization Brussels, Belgium, 2004.
- Eurocode-8. Eurocode 8: Design of structures for earthquake resistance - Part 3: Assessment and retrofitting of buildings (EN 1998-3), European Committee of Standardization Brussels, Belgium, 2005.
- R.E.B.A.P. Regulamento para Estruturas de Betão Armado e Pré-Esforçado, Diário da República, 1983.
- R.S.A. Regulamento de Segurança e Acções para Estruturas de Edifícios e Pontes, Diário da República, 1983.