

Comparison of Current-Source and Voltage-Source Shunt Active Power Filters for Harmonic Compensation and Reactive Power Control

J. G. Pinto¹, Bruno Exposto¹, Vitor Monteiro¹, L. F. C. Monteiro², Carlos Couto¹, João L. Afonso¹
 1 - Centro Algoritmi – University of Minho – Guimarães, Portugal

2 – State University of Rio de Janeiro – Electronics Engineering Program – Rio de Janeiro, Brazil

E-mails: gabriel.pinto@agoritm.uminho.pt, bruno.exposto@agoritm.uminho.pt, vitor.monteiro@agoritm.uminho.pt, lmonteiro@uerj.br, carlos.couto@agoritm.uminho.pt, joao.l.afonso@agoritm.uminho.pt

Abstract – This paper presents the comparison between two three-phase Shunt Active Power Filters (SAPFs), one with Current-Source Inverter (CSI) and the other with Voltage-Source Inverter (VSI), which are used to compensate current harmonics and to control reactive power. The control algorithm of both SAPFs is based on the Instantaneous Reactive Power Theory (p - q Theory). The comparison here presented focuses on the Total Harmonic Distortion (THD) and RMS values of the compensated currents, and in the Total Power Factor (TPF) of the installation.

Keywords – Power Quality, Harmonics, Reactive Power, Shunt Active Power Filter, Phase-Locked Loop, Digital Control, Voltage-Source Inverter (VSI), Current-Source Inverter (CSI).

I. INTRODUCTION

The Power Quality is one of the most important characteristics of the modern electrical energy distribution systems. Consequently, the poor Power Quality can cause enormous economic losses to the industrial facilities. In Europe, Power Quality problems costs more than €150 billion a year to business [1]. The increasing use of rectifiers, thyristor power converters, arc furnaces, switching power supplies and other non-linear loads is known to cause serious problems in electric power systems [2]. Therefore the use of this type of loads imposes the development of solutions for the mitigation and reduction of the Power Quality problems. Some adopted solutions for these problems, such as passive filters for harmonic mitigation, or capacitor banks for reactive power compensation, can cause other problems such as resonances, voltage transients and others [3]. Shunt Active Power Filters (SAPFs) are a good solution, and have been developed over the years [4][5][6].

There are several topologies of SAPFs, but they can be generally classified in two main groups: Voltage-Source SAPFs and Current-Source SAPFs, depending of the topology of inverter that is used.

In this paper are presented several computer simulations results of a Voltage-Source and a Current-Source SAPF, controlled using the p - q Theory.

II. CONTROL OF THE SHUNT ACTIVE POWER FILTERS

The controller of the SAPFs presented in this paper uses the p - q Theory proposed by Akagi et al [7]. This power theory has been largely used in the implementation of SAPFs

over the years, and has provided good results with different types of electrical installations and loads [8][9].

The p - q Theory works in the α - β reference frame, and therefore, the electrical grid voltages (v_a, v_b, v_c) and the load currents (i_a, i_b, i_c) must be converted to this reference frame by applying the Clarke transformation, given by (1) and (2):

$$\begin{bmatrix} v_\alpha \\ v_\beta \end{bmatrix} = \sqrt{\frac{2}{3}} \cdot \begin{bmatrix} 1 & -\frac{1}{2} & -\frac{1}{2} \\ 0 & \frac{\sqrt{3}}{2} & -\frac{\sqrt{3}}{2} \end{bmatrix} \cdot \begin{bmatrix} v_a \\ v_b \\ v_c \end{bmatrix} \quad (1)$$

$$\begin{bmatrix} i_\alpha \\ i_\beta \end{bmatrix} = \sqrt{\frac{2}{3}} \cdot \begin{bmatrix} 1 & -\frac{1}{2} & -\frac{1}{2} \\ 0 & \frac{\sqrt{3}}{2} & -\frac{\sqrt{3}}{2} \end{bmatrix} \cdot \begin{bmatrix} i_a \\ i_b \\ i_c \end{bmatrix} \quad (2)$$

The p - q Theory power components are calculated using the expressions (3) and (4), where p is the instantaneous real power, and q is the instantaneous imaginary power (by definition).

$$p = v_\alpha \cdot i_\alpha + v_\beta \cdot i_\beta \quad (3)$$

$$q = v_\beta \cdot i_\alpha - v_\alpha \cdot i_\beta \quad (4)$$

Each one of the instantaneous power components can be separated into an average value and an oscillating value. The physical meaning of each of the instantaneous powers is:

\bar{p} – Average value of the instantaneous real power p . Corresponds to the energy per time unit transferred from the power source to the load, in a balanced way through the three phases;

\tilde{p} – Oscillating value of the instantaneous real power. It is the energy per time unity that is exchanged between the power source and the load, through the three phases;

q – The instantaneous imaginary power. Corresponds to the power that is exchanged between the phases of the load. This component does not imply any transference of energy between the power source and the load, but is responsible for the existence of undesirable currents.

Normally, only the average value of the instantaneous real power (\bar{p}) is desirable, and the other power components can be compensated using a SAPF. In order to calculate the reference currents that the active filter should inject it is necessary to separate the desired power components from the

undesired ones. The undesired power components are denominated p_x and q_x .

In addition to the instantaneous power components defined by the p - q Theory, there is also a component, p_{reg} , which is used to regulate the capacitor voltage and the inductor current, in the DC side of the Voltage-Source and Current-Source SAPFs, respectively. This regulation, in both of the presented SAPFs, is done with a Proportional-Integral (PI) controller, and the error between the reference voltage (V_{ref}) or the reference current (I_{ref}) and the voltage or the current measured at the DC side of the inverter (V_{DC} or I_{DC}). The component p_{reg} is an active power component and is related to the SAPFs steady state operation losses. p_{reg} must be supplied by the electrical grid, and therefore this power component is included in the calculation of p_x . So, the values of the power components that the SAPFs should produce are given by:

$$p_x = \tilde{p} - p_{reg} \quad (5)$$

$$q_x = q \quad (6)$$

The undesired power components and p_{reg} are then used to determine the compensation currents in the α - β coordinates using the expression (7):

$$\begin{bmatrix} i_{ca}^* \\ i_{cb}^* \end{bmatrix} = \frac{1}{v_\alpha^2 + v_\beta^2} \cdot \begin{bmatrix} v_\alpha & v_\beta \\ -v_\beta & v_\alpha \end{bmatrix} \cdot \begin{bmatrix} p_x \\ q_x \end{bmatrix} \quad (7)$$

The reference compensation currents in the a - b - c coordinates (i_{ca}^* , i_{cb}^* , i_{cc}^*) are determined by applying the inverse Clarke transformation to the currents in the α - β reference frame, as demonstrated in expression (8):

$$\begin{bmatrix} i_{ca}^* \\ i_{cb}^* \\ i_{cc}^* \end{bmatrix} = \sqrt{\frac{2}{3}} \cdot \begin{bmatrix} \frac{1}{\sqrt{2}} & -\frac{1}{2} & \frac{\sqrt{3}}{2} \\ \frac{1}{\sqrt{2}} & -\frac{1}{2} & -\frac{\sqrt{3}}{2} \\ 0 & 0 & 0 \end{bmatrix} \cdot \begin{bmatrix} i_{ca}^* \\ i_{cb}^* \end{bmatrix} \quad (8)$$

A. Modified p - q Theory for Sinusoidal Source-Currents

The application of the p - q Theory produces reference compensation currents to the SAPFs that result in a constant power at the source. In three-phase power systems with distorted and/or unbalanced voltages it is not possible at the same time to have constant power flow from the source to the load, and also to have sinusoidal currents at the source. In this way, when the electrical grid voltages are distorted and/or unbalanced, the operation of the SAPFs results in distorted compensated currents at the source, which are necessary to obtain constant power at the source. If instead of constant power at the source is preferred to obtain sinusoidal currents at the source, it is possible to modify the p - q Theory in order to achieve it, even when the electrical grid voltages are not sinusoidal and balanced. For this purpose, instead of directly use the grid voltages to perform the calculations of the power components defined in the p - q Theory, is used the positive sequence of the fundamental component of these voltages. To obtain the positive sequence of the fundamental component of

the voltages it can be used a digital Phase-Locked Loop (PLL). This p - q Theory modification was successfully applied both in Current-Source [10] and Voltage-Source SAPFs [4]. In Fig. 1 it can be seen the block diagram of the digital controller of the SAPFs, based on the p - q Theory. Fig. 1 (a) shows the main algorithm and Fig. 1 (b) shows a detailed view of the digital PLL that is used to obtain the positive sequence of the fundamental component of the grid voltages [11].

III. SHUNT ACTIVE POWER FILTERS TOPOLOGIES

The topology of each active filter is presented in Fig. 2. As it can be seen, the power stage of the Voltage-Source SAPF is composed by a two-level Voltage-Source Inverter (VSI) that uses six IGBTs and a capacitor at the DC link. The passive filters used in this topology are LC low pass filters. To damp the response of the passive filter in their resonance frequency, was placed a resistor with low value, in series with the capacitors. The Current-Source SAPF power stage is constituted by a Current-Source Inverter (CSI) that uses six IGBTs with reverse blocking diodes in series with the IGBTs and an inductor in the DC link. The passive filters are also LC passive filters, but the arrangement is different from the Voltage-Source SAPF. In TABLE I is possible to see all the parameter values of both SAPFs.

Three different types of balanced three-phase loads were used to test the performance of the SAPFs: Load 1 - three inductors (L_L) and three resistors (R_L) connected in Y; Load 2 - a full-bridge rectifier with a resistor (R_{DC2}) and an inductor (L_{DC1}) in the DC side, and three input inductors (L_{I2}); Load 3 - a full-bridge rectifier with a resistor (R_{DC1}) and a capacitor (C) in the DC side, and three input inductors (L_{I1}).

The simulations were performed using the PSIM software.

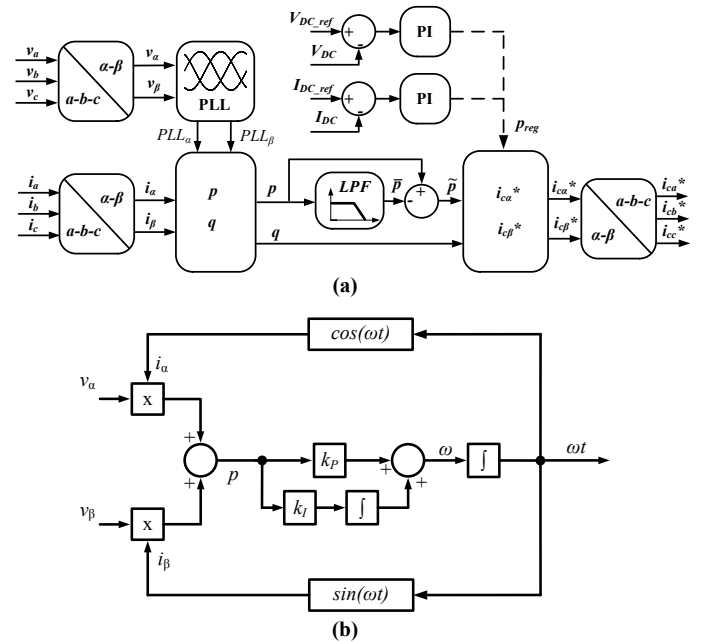

Fig. 1. Block diagram of the SAPFs digital controller: (a) Implementation of the p - q Theory; (b) Phase-Locked Loop.

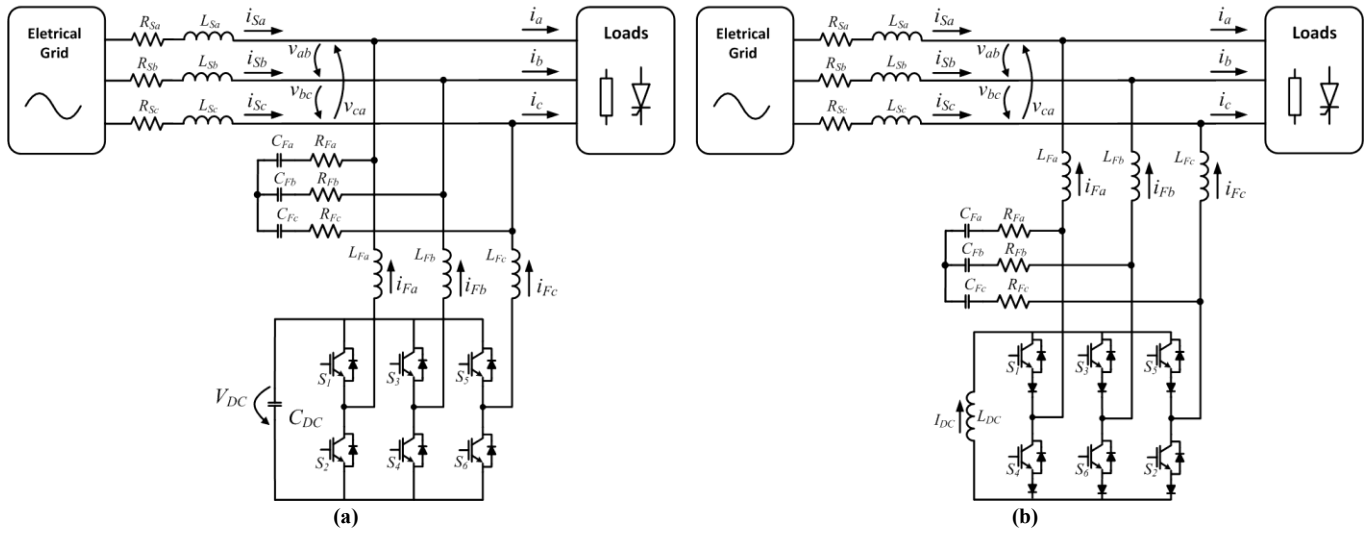

Fig. 2. SAPFs power inverters topologies: (a) Voltage-Source SAPF; (b) Current-Source SAPF.

TABLE I
SIMULATION PARAMETERS OF THE SHUNT ACTIVE POWER FILTERS

VS-SAPF Parameters		CS-SAPF Parameters	
V_{LI}	200 V	V_{LI}	200 V
L_{sx}	0.1 mH	L_{sx}	0.1 mH
R_{sx}	0.1 Ω	R_{sx}	0.1 Ω
C_{DC}	3 mF	L_{DC}	128 mH
V_{DC}	400 V	I_{DC}	Variable
C_{Fx}	20 μ F	C_{Fx}	60 μ F
L_{Fx}	5 mH	L_{Fx}	2.5 mH
R_{Fx}	1 Ω	R_{Fx}	3.5 Ω

TABLE II
LOAD SIMULATION PARAMETERS

Load Parameters					
Load 1: (RL load)		Load 2: (Full-Bridge Rectifier with RL load)		Load 3: (Full-Bridge Rectifier with RC load)	
L_L	40 mH	L_{D2}	3 mH	L_{D1}	1 mH
R_L	7 Ω	R_{DC2}	10 Ω	R_{DC1}	12 Ω
		L_{DC1}	14 mH	C	0.6 mF

In both of the SAPFs was used Periodic-Sampling modulation technique. The implementation of this switching technique for the Voltage-Source SAPF is done by periodically sampling the inverter output current (i_{fx}) and then making a comparison with the reference compensation current (i_{cx}^*). The IGBTs are then switched according with the result of this comparison. In the implementation of the Periodic-Sampling switching technique in the Current-Source SAPF, instead of directly switching the IGBTs, the result of the comparison is sent to a combinational logic circuit that generates the correct pulse patterns to this type of inverter. The IGBTs are then switched according with the result of this combinational logic circuit. The differences in the switching patterns reside in the fact that in the Voltage-Source SAPF two IGBTs from the same inverter leg cannot be conducting

simultaneously, otherwise the DC side capacitor is short-circuited and the current can destroy the IGBTs. In the Current-Source SAPF the current of the DC side inductor must never be interrupted, otherwise the voltage of the DC side inductor increases to values that can destroy the IGBTs of the inverter. To avoid that, all the states involve two IGBTs conducting at the same time. In the case of the Voltage-Source SAPF are introduced dead-times to ensure that the DC side capacitor is not short-circuited. In the case of the Current-Source SAPF it is necessary to ensure the overlapping of the switching pulses.

In the simulations of both of the SAPFs, the sampling frequency of the digital controller was fixed in 30 kHz and the minimum time between switching transitions was limited by this sampling frequency. Therefore, the switching frequency is not fixed and has a maximum value of 15 kHz.

IV. SIMULATION RESULTS

In Fig. 3 it is possible to see simulation results of the source, load and active filter currents with the SAPFs compensating three different loads. As it can be seen, after the compensation with both SAPFs, the source currents waveforms become almost sinusoidal and in phase with the electrical grid voltage. This indicates that the SAPFs are operating correctly. The harmonic spectrum of the source and load currents can be seen in Fig. 4. The harmonic spectrum of the source currents in all the simulated cases is indicative that both of the SAPFs are operating well and that they compensate the current harmonics correctly. This is noticeable when the SAPFs compensate the non-linear loads.

In TABLE III is possible to see a summary of the simulation results obtained with the SAPFs compensating the three different loads. The results from the compensation of the RL load show that the RMS values of the source currents are inferior to the values of the load currents. The fact that the total power factor after the compensation is nearly unitary indicates that both of the SAPFs are performing well.

Simulation Results of the Voltage-Source SAPF

Simulation Results of the Current-Source SAPF

Compensation of Load 1 (RL load):

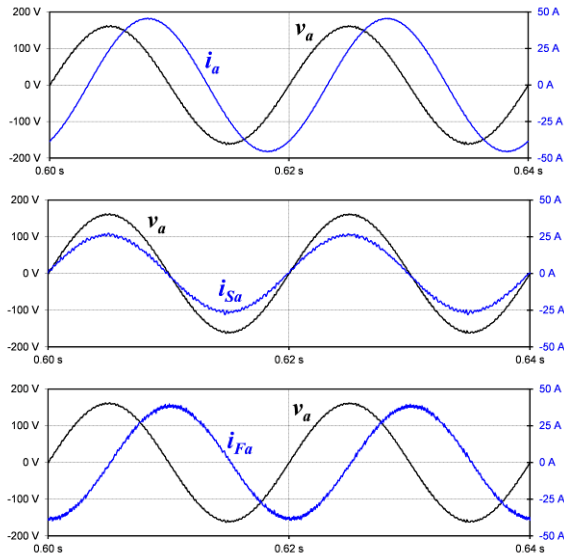

Load

Source

Filter

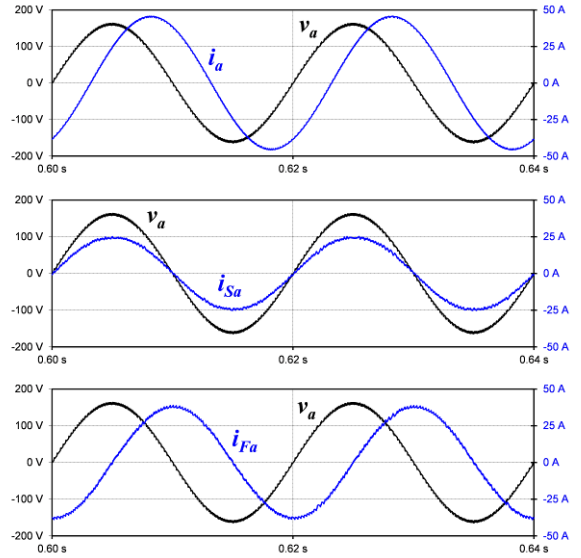

Load

Source

Filter

Compensation of Load 2 (Full-bridge rectifier with RL load):

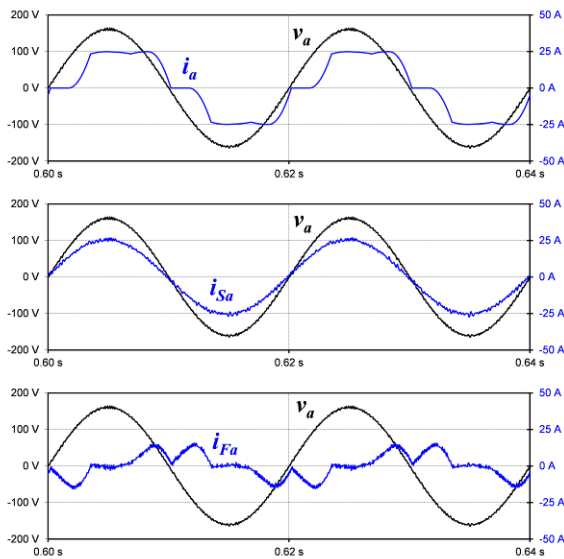

Load

Source

Filter

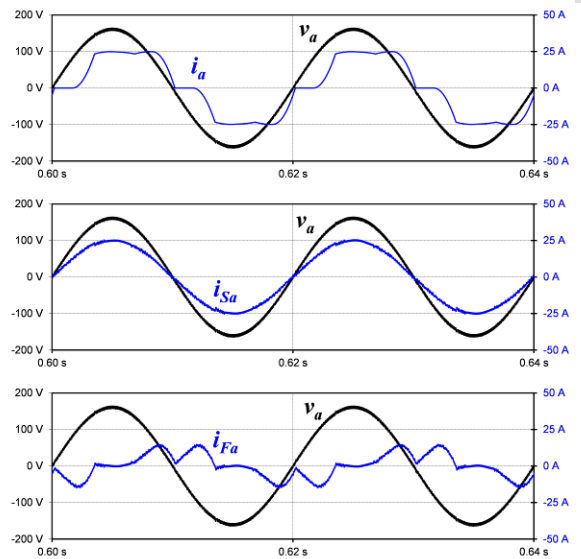

Compensation of Load 3 (Full-bridge rectifier with RC load):

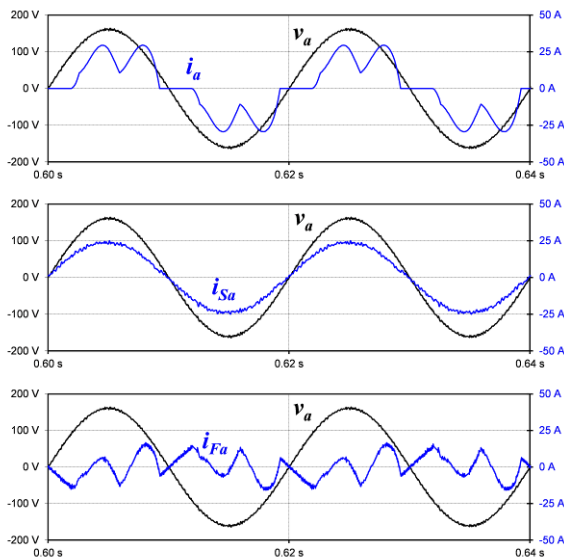

Load

Source

Filter

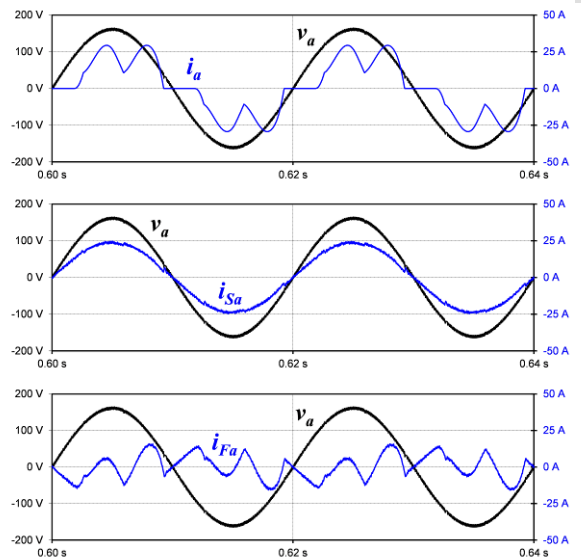
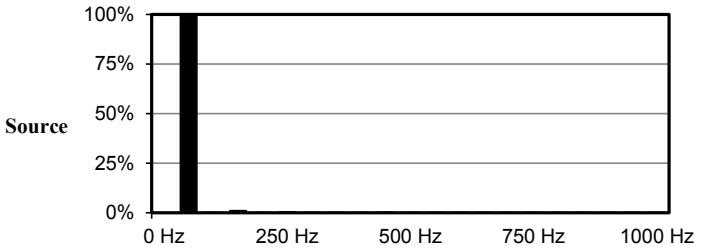
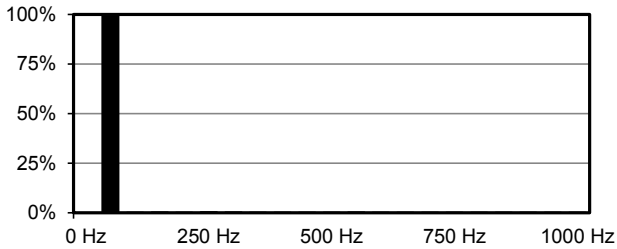
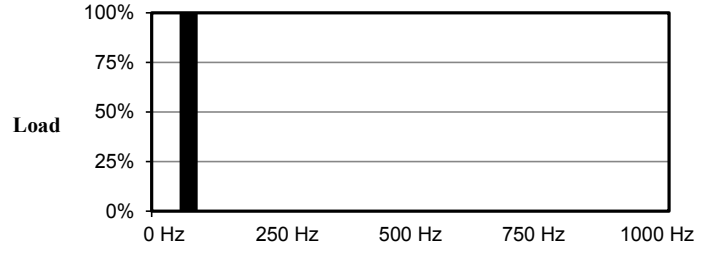
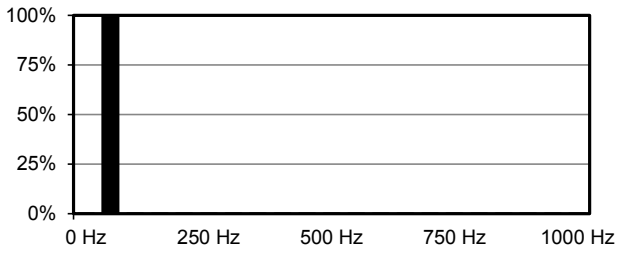

Fig. 3. Waveforms of grid voltage and currents at the load, source and active filter with Voltage-Source SAPF and with Current-Source SAPF, for three different types of loads.

Simulation Results with the Voltage-Source SAPF

Simulation Results with the Current-Source SAPF

Compensation of Load 1 (RL load):



Compensation of Load 2 (Full-bridge rectifier with RL load):

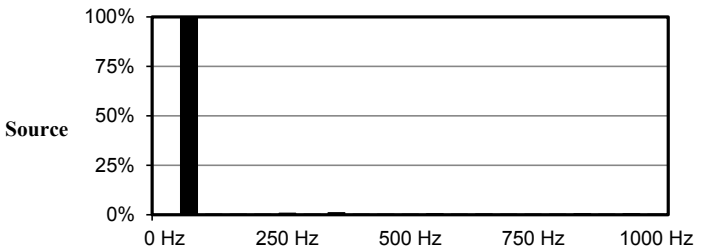
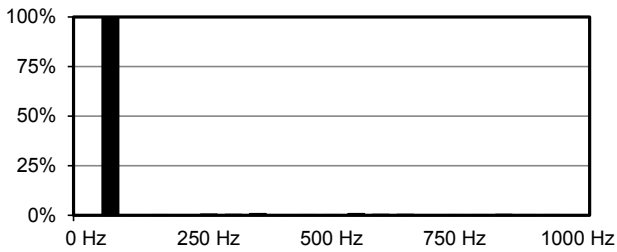
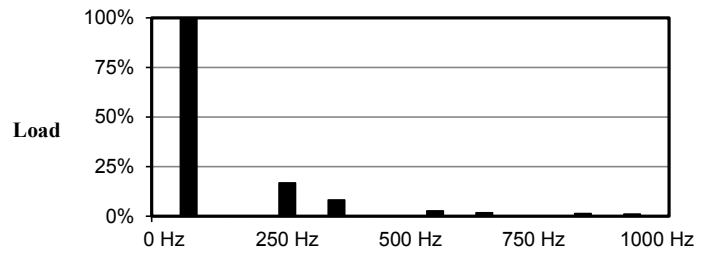
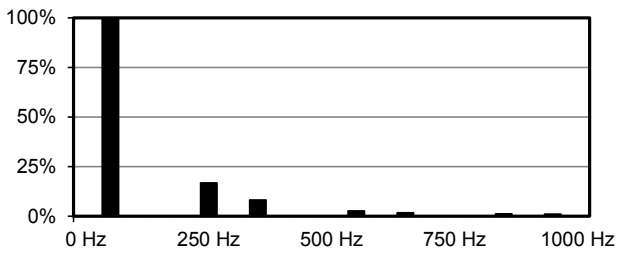

Compensation of Load 3 (Full-bridge rectifier with RC load):

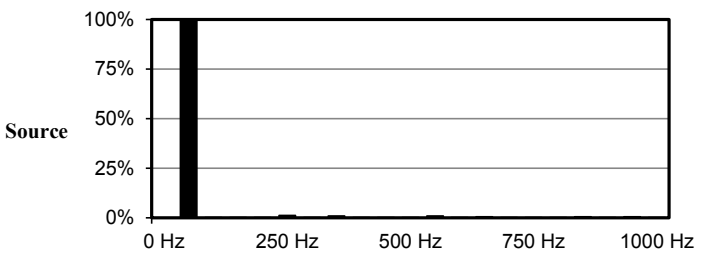
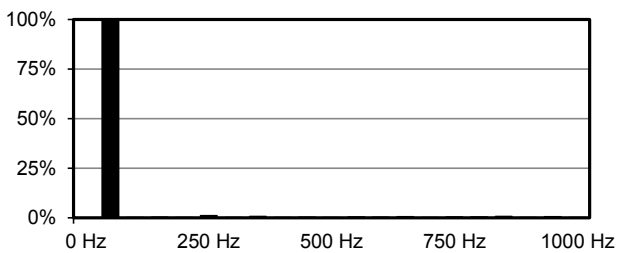
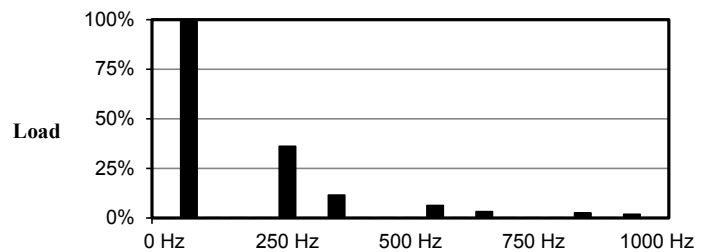
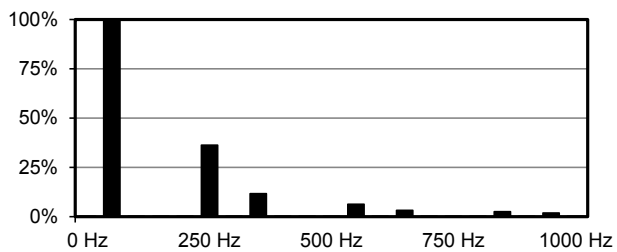

Fig. 4. Harmonic spectrum of the currents at the load and source with Voltage-Source SAPF and with Current-Source SAPF, for three different types of loads.

TABLE III
SIMULATION RESULTS OF THE SHUNT ACTIVE POWER FILTERS

VS-SAPF		CS-SAPF	
Load 1 (RL load)			
P_S	6320 W	P_S	6082 W
S_S	6333 VA	S_S	6100 VA
TPF_S	0.998	TPF_S	0.997
THD_{IS}	1.1%	THD_{IS}	1.2%
I_S (RMS)	18.58 A	I_S (RMS)	17.90 A
P_L	5902 W	P_L	5908 W
S_L	10957 VA	S_L	10970 VA
TPF_L	0.538	TPF_L	0.538
THD_{IL}	0.4%	THD_{IL}	0.4%
P_L/P_S	93.3%	P_L/P_S	97.1%
I_L (RMS)	32.10 A	I_L (RMS)	32.10 A
Load 2 (Full-bridge rectifier with RL load)			
P_S	6154 W	P_S	6084 W
S_S	6163 VA	S_S	6103 VA
TPF_S	0.998	TPF_S	0.996
THD_{IS}	1.7%	THD_{IS}	1.4%
I_S (RMS)	18.10 A	I_S (RMS)	17.9 A
P_L	5933 W	P_L	5935 W
S_L	6534 W	S_L	6540 VA
TPF_L	0.908	TPF_L	0.907
THD_{IL}	18.9%	THD_{IL}	18.9%
P_L/P_S	96.4%	P_L/P_S	97.5%
I_L (RMS)	19.20 A	I_L (RMS)	19.2 A
Load 3 (Full-bridge rectifier with RC load)			
P_S	5796 W	P_S	5813 W
S_S	5873 VA	S_S	5832 VA
TPF_S	0.986	TPF_S	0.997
THD_{IS}	2.3%	THD_{IS}	2.2%
I_S (RMS)	17.0 A	I_S (RMS)	17.10 A
P_L	5571 W	P_L	5571 W
S_L	6207 VA	S_L	6206 VA
TPF_L	0.897	TPF_L	0.897
THD_{IL}	38.8%	THD_{IL}	38.68%
P_L/P_S	96.1%	P_L/P_S	95.8%
I_L (RMS)	18.20 A	I_L (RMS)	18.20 A

When compensating the full-bridge rectifier with RL load the performance of the SAPFs is also similar. The source currents THD after the compensation is slighter higher in the case of the Voltage-Source SAPF, nevertheless the difference between the two SAPFs performance is negligible. In the compensation of the full-bridge rectifier with RC load, the performance of both SAPFs is once more very similar. The source current THD values after the compensation are much inferior to the load currents THD, and there is almost no difference in the source currents THDs of both SAPFs. The RMS values of the currents in this case are slightly inferior in the source, after compensation, than in the load.

V. CONCLUSIONS

In this paper was presented a comparison between a Voltage-Source and a Current-Source Shunt Active Power Filter (SAPF) when compensating three different types of loads. The comparison between the two SAPFs addressed the Total Harmonic Distortion (THD) and RMS values of the compensated currents and the Total Power Factor (TPF). As the results presented in this paper show, the performance of both SAPFs is very similar. The values of the source currents THDs after the compensation are similar in both cases. The RMS values of the currents in the source are reduced in all the cases and more substantially when the SAPFs compensate the RL load. In both cases the p - q Theory used in the control system performs well and successfully identifies the currents components that must be compensated by the SAPFs. For future work it will be done a comparison of the SAPFs dynamic performance in response to variations in the loads.

ACKNOWLEDGMENT

This work is financed by FEDER Funds, through the Operational Program for Competitiveness Factors – COMPETE, and by National Funds through FCT – Foundation for Science and Technology of Portugal, under projects: PTDC/EEA-EEL/104569/2008; FCOMP-01-0124-FEDER-022674 and MIT-PT/EDAM-SMS/0030/2008.

REFERENCES

- [1] "Poor Power Quality costs European business more than € 150 billion a year," Leonardo Power Quality Initiative - European Copper Institute, 2008.
- [2] A. Bachry and Z. A. Styczynski, "An Analysis of Distribution System Power Quality Problems Resulting from Load Unbalance and Harmonics," in *IEEE PES Transmission and Distribution Conference and Exposition (IEEE Cat. No.03CH37495)*, 2003, pp. 763-766.
- [3] J. G. Pinto, R. Pregitzer, L. F. C. Monteiro, C. Couto, and J. L. Afonso, "A Combined Series Active Filter and Passive Filters for Harmonics, Unbalances and Flicker Compensation," in *2007 Int. Conference on Power Engineering, Energy and Electrical Drives*, 2007, pp. 54-59.
- [4] J. Afonso, C. Couto, and J. Martins, "Active Filters with Control Based on the p - q Theory," *IEEE Industrial Electronics Society Newsletter*, vol. 47, pp. 5-10, 2000.
- [5] B. Singh, K. Al-haddad, and A. Chandra, "A Review of Active Filters for Power Quality Improvement," *IEEE Transactions on Industrial Electronics*, vol. 46, no. 5, pp. 960-971, 1999.
- [6] R. Pregitzer, J. G. Pinto, M. J. Sepúlveda, and J. L. Afonso, "Parallel Association of Shunt Active Power Filters," in *ISIE 2007. IEEE Int. Symposium on Industrial Electronics*, 2007, no. 1, pp. 2493 - 2498.
- [7] H. Akagi, Y. Kanazawa, and A. Nabae, "Generalized Theory of the Instantaneous Reactive Power in Three-Phase Circuits," in *IPEC'83 - Int. Power Electronics Conf.*, 1983, pp. 1375-1386.
- [8] J. G. Pinto, P. Neves, D. Gonçalves, and J. L. Afonso, "Field results on developed three-phase four-wire Shunt Active Power Filters," *IECON 2009. 35th Annual Conference of IEEE*, 2009, pp. 480 - 485.
- [9] B. Exposto, H. Gonçalves, J. G. Pinto, J. L. Afonso, and C. Couto, "Three Phase Four Wire Shunt Active Power Filter from Theory to Industrial Facility Tests," in *11th Int. Conference on Electrical Power Quality and Utilization - EPQU*, 2011, no. 3, pp. 1 - 5.
- [10] B. Exposto, H. Carneiro, G. Pinto, C. Couto, and J. L. Afonso, "Simulations of a current-source Shunt Active Power Filter with Carrier-Based PWM and Periodic Sampling Modulation Techniques," in *EPE 2011 14th European Conference on Power Electronics and Applications*, 2011, pp. 1-8.
- [11] L. G. Barbosa Rolim, D. Rodrigues da Costa Jr., and M. Aredes, "Analysis and Software Implementation of a Robust Synchronizing PLL Circuit Based on the pq Theory," *IEEE Transactions on Industrial Electronics*, vol. 53, no. 6, pp. 1919-1926, Dec-2006.